

Linear Motion Systems for **Railways**

鉄道市場向け直動システム



Exceed Expectations, Motion For Innovation

Development of new business areas

THK continues to provide high-quality products, and is expanding its business domain from its core technology to various fields such as railways, aircraft, and automobiles.

Development system

In addition to improving development speed to expand applications in the railway industry, we are promoting the development of railway products with an eye toward five and ten years down the road.

新規分野への展開

THKは高品質な製品を提供し続け、培った技術から、鉄道、航空機、自動車など様々な分野へと、事業領域の拡大をしています。

開発体制

鉄道業界の用途拡大に向けて開発スピードの向上を図るとともに、5年先、10年先を見据えた鉄道製品の開発を推進しています。



THK core technology THKのコアテクノロジー



Using rolling motion to achieve linear motion reduces friction resistance, improves efficiency through smooth motion, and reduces the energy used by equipment.

直線運動を「転がり」化することで摩擦抵抗を軽減し、滑らかな動きで効率の向上を生み出し、装置の省エネ化を可能にしました。

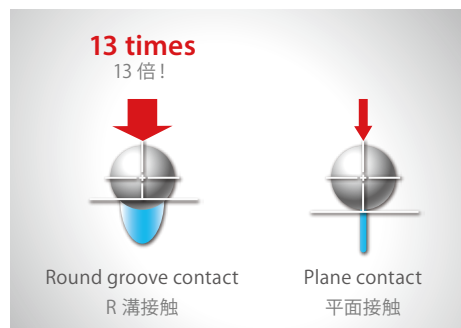

THK's various linear motion systems have high stability because they roll on a round groove that approximates the ball diameter, and can withstand loads approximately 13 times greater than conventional plane contact types.

THK の様々な直動システムはボール径に近似した R 形状の溝をボールが転がる方式のため安定性が高く、従来の平面接触型に比べて約 13 倍の荷重にも耐えられます。

Bringing THK motion to the railway industry

動くところはすべて THK — 鉄道分野における THK の提案 —

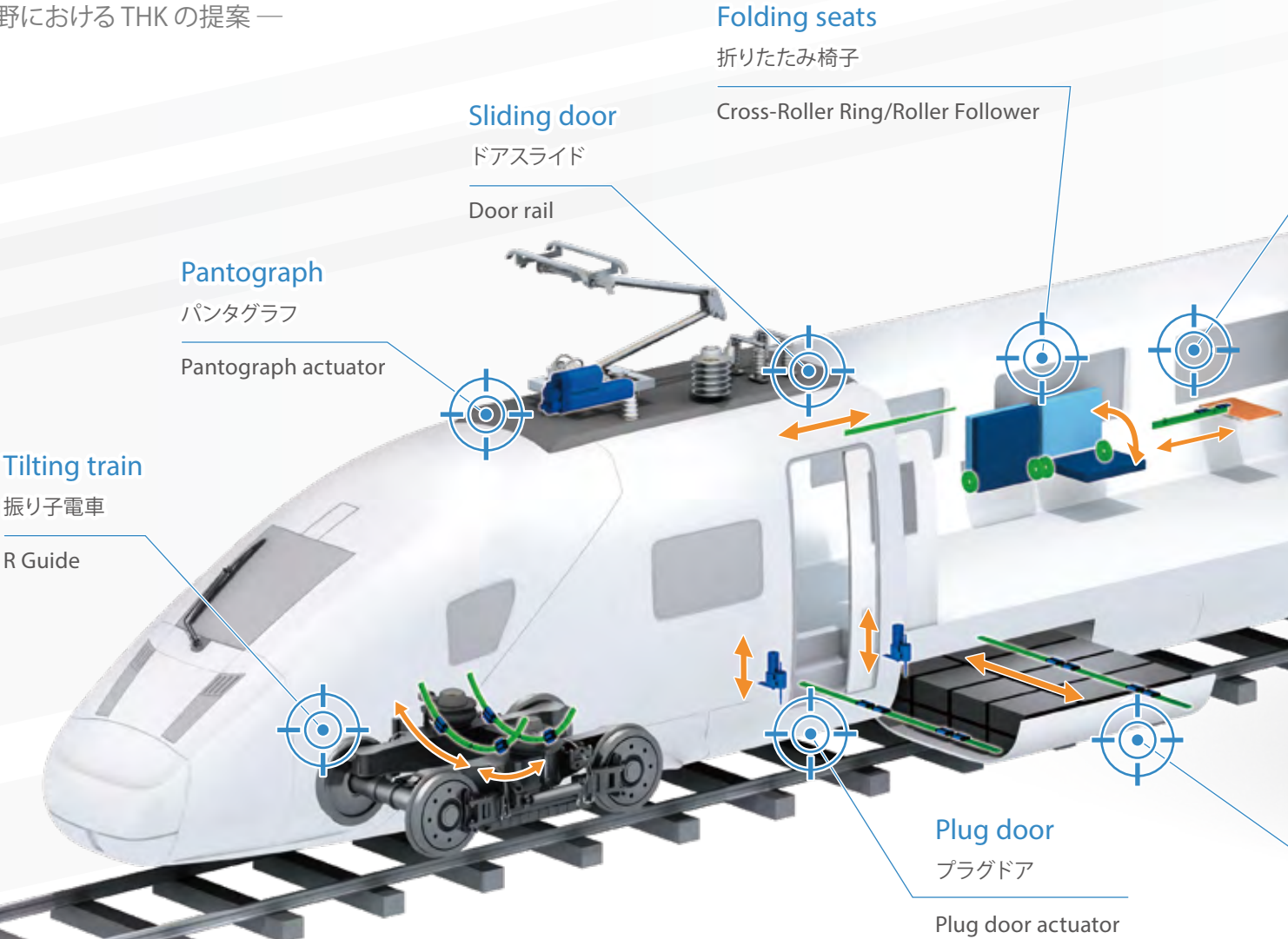

Movable/adjustable table

テーブル移動 / 任意位置固定

Clamper/LM Guide

Maintenance rack

メンテナンス用の棚

Model PC Electric Actuator/LM Guide

Platform door

ホームドア

LM Guide

Luggage racks

荷物置き

LM Guide/R Guide

Rotating/sliding seats

シート回転/スライド

LM Guide/Clamper/Model MPG

Battery case

バッテリーケース

LM Guide

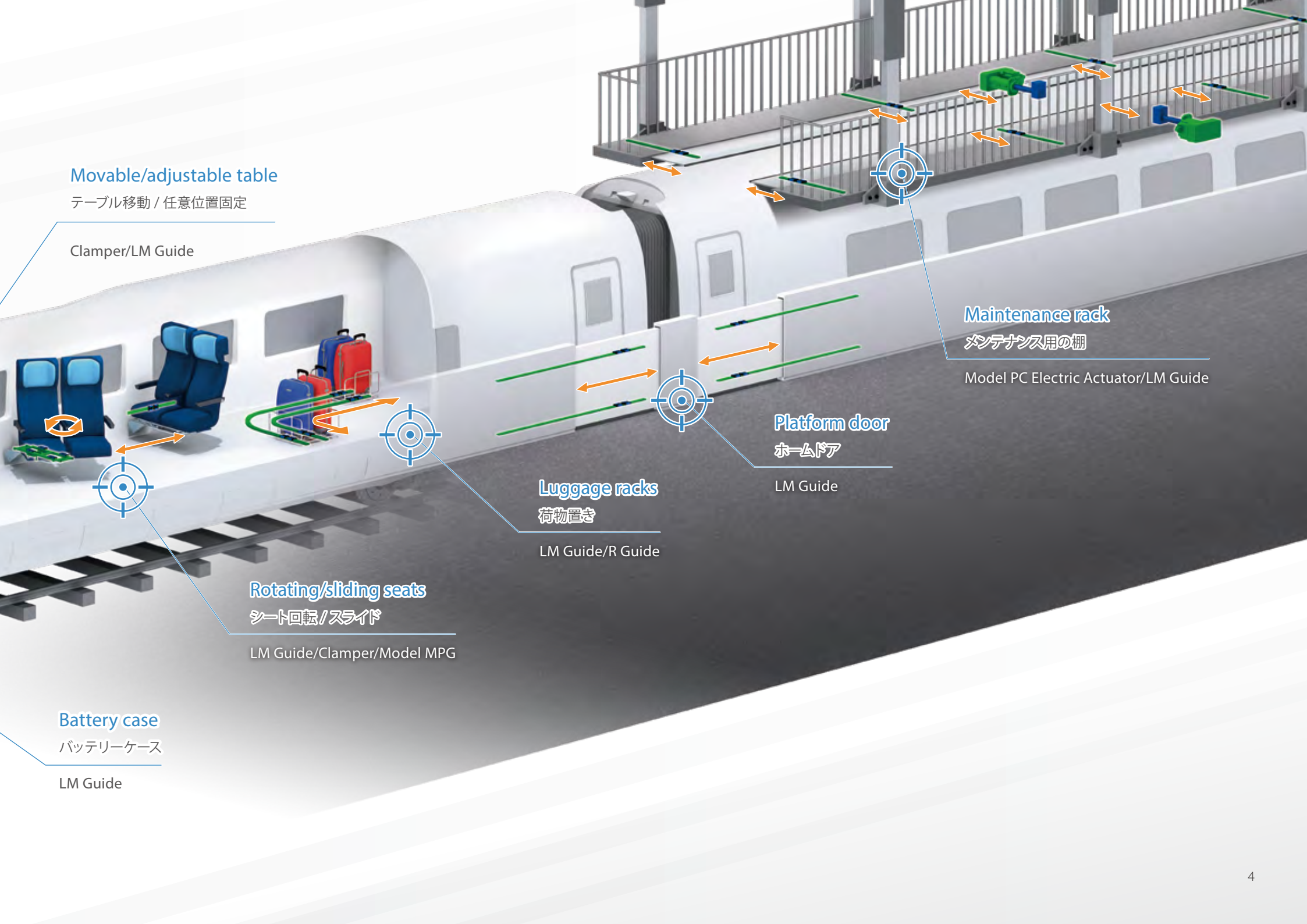

Value provided

提供価値



Lineup ラインナップ

Model HSR

HSR 形

The HSR is the world standard size for LM Guides, and it can bear loads from every direction equally.

HSR 形はあらゆる方向の荷重を受けることが可能な、世界標準サイズの LM ガイドです。



Model UGR

UGR 形

The UGR is a comparatively lower-priced LM Guide that can be used in a variety of devices in homes, offices, and more.

UGR は、住宅機器やオフィス機器などの多種多様な用途に使用できる比較的安価な LM ガイドです。



Model ATG

ATG 形

The ATG is a guide with high misalignment tolerance and superior load resistance.

ATG 形は、取付面誤差の吸収が可能な、耐荷重性に優れた有限タイプのガイドです。



Model FBL

FBL 形

The FBL is a thin, compact slide rail that is easy to install.

FBL 形は、薄形コンパクトで取付けが簡単なスライド式レールです。



Model HCR

HCR 形

The HCR is an LM Guide capable of arc motions that rotary bearings are not.

HCR 形は、回転ベアリングでは厳しい円弧運動を実現する LM ガイドです。



Model TPG

TPG 形

The TPG is a lightweight, highly rigid telescopic guide.

TPG は、高剛性と軽量化を実現したテレスコピックガイドです。



Model PC

PC 形

The PC is a compact press actuator with high thrust.

PC 形は、コンパクトで高推力のプレス用アクチュエータです。



Model ARG

ARG 形

The Roller Type Guide is a guide with an automatic alignment function.

ローラータイプガイドは、自動調心性を有したガイドです。



Model MPG

MPG 形

The MPG is a lightweight rotary bearing capable of stable motion.

MPG 形は、軽量化と安定した動作を実現した回転ベアリングです。



Seating (Adaptable) シート (多様性)

Rotating/sliding seats シート回転 / スライド

Sliding seats

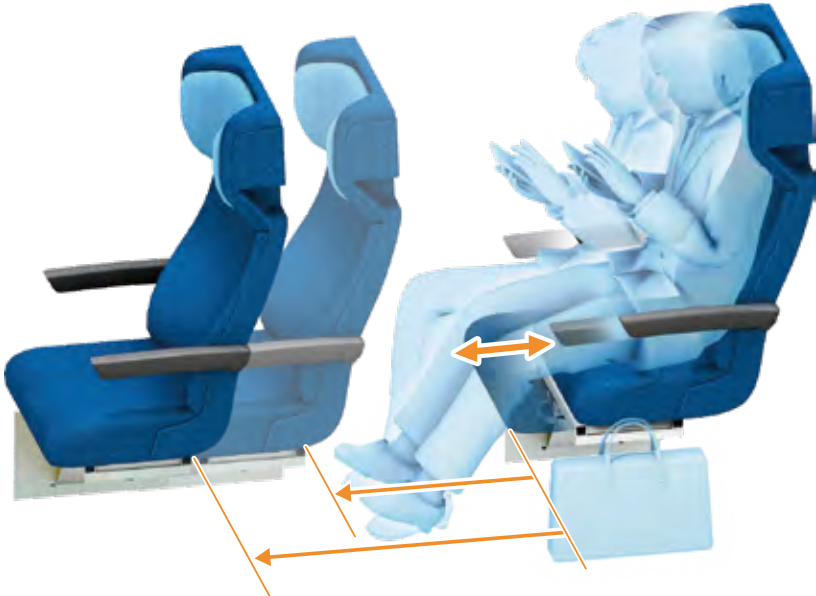

Rotating seats

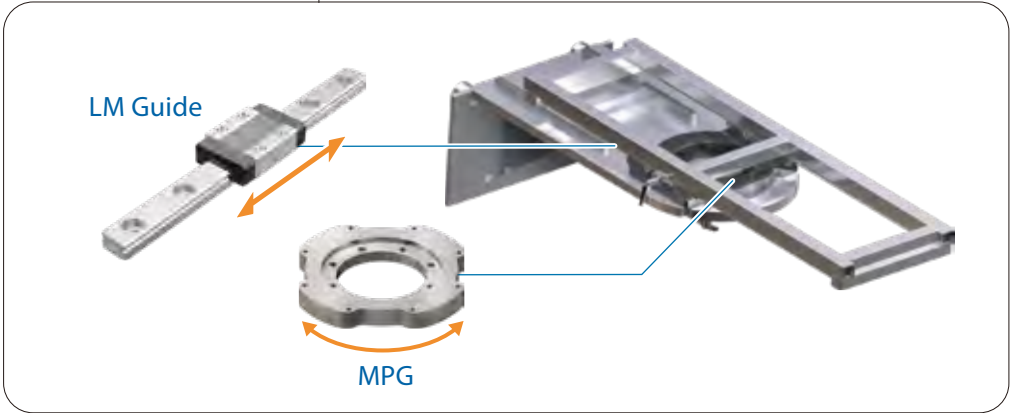

Seating (Comfort) シート (快適性)

Movable/adjustable tables

テーブル移動 / 任意位置固定

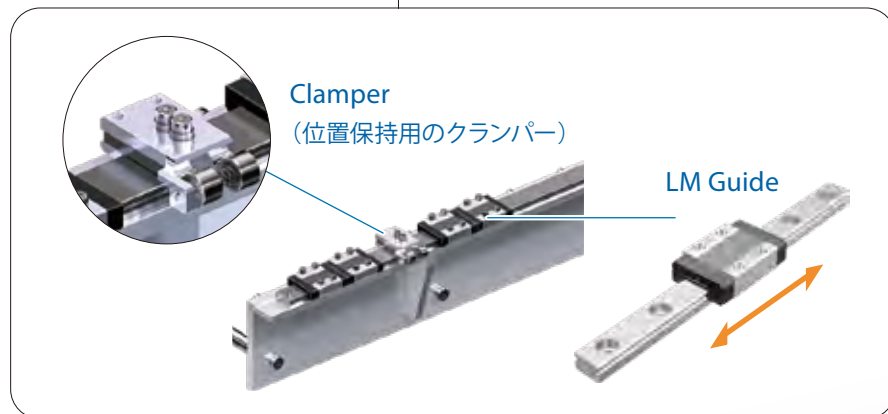
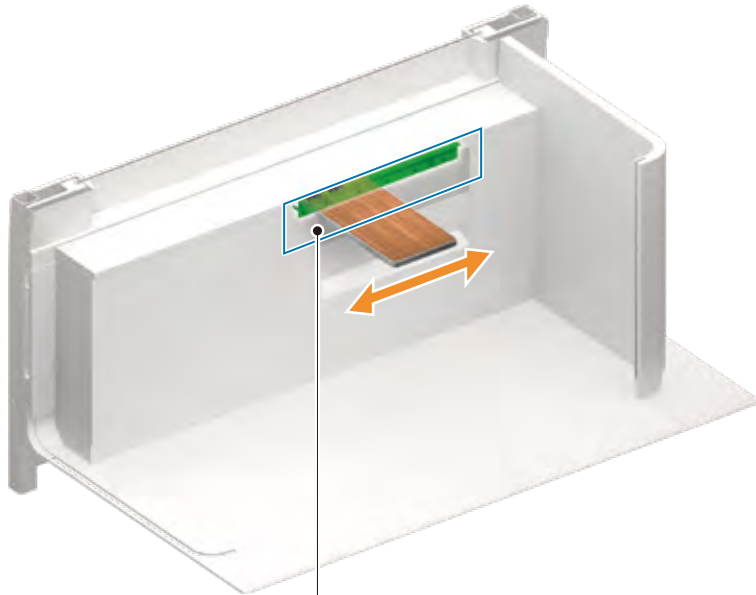

Reclining seats

リクライニング

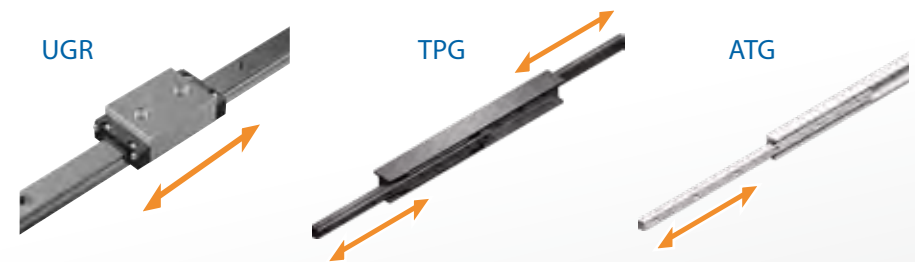

Railway vehicle (Linear motion system) 車体 (直動システム)

Sliding doors
ドアスライド



Tilting trains
振り子電車

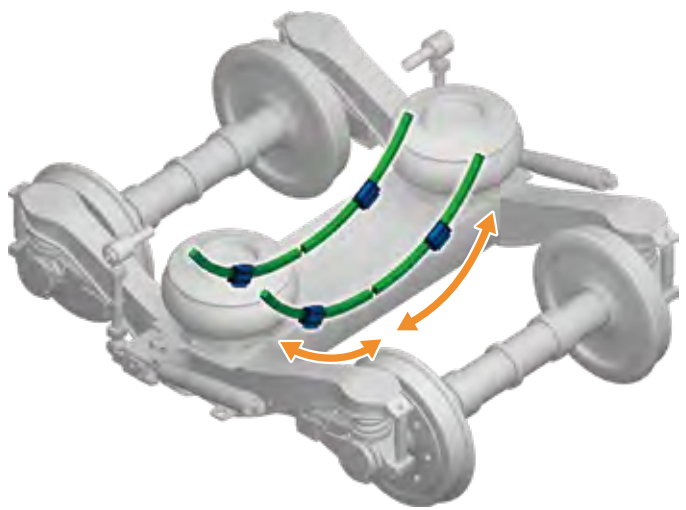

FBL

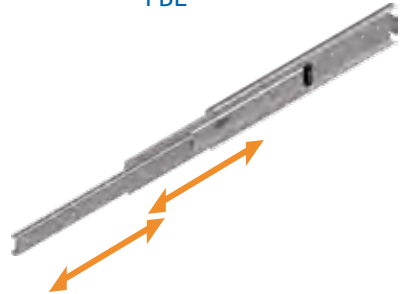

Roller Type Guide



R Guide

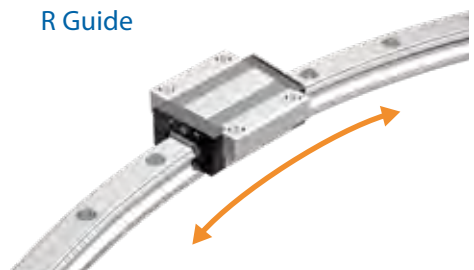

Railway vehicle (Motorization) 車体 (電動化)

Plug doors

プラグドア



Pantographs

パンタグラフ

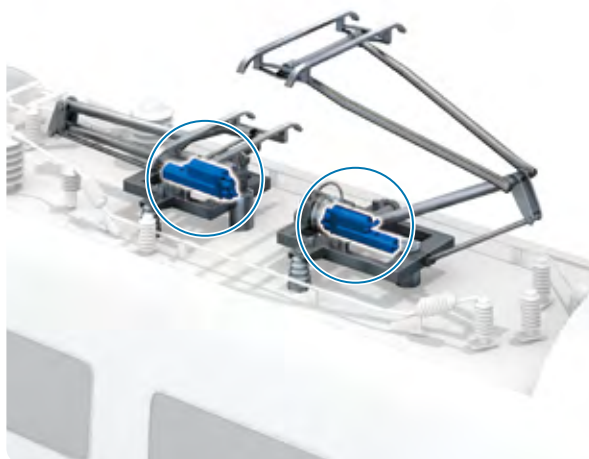

Maintenance rack

メンテナンス用の棚

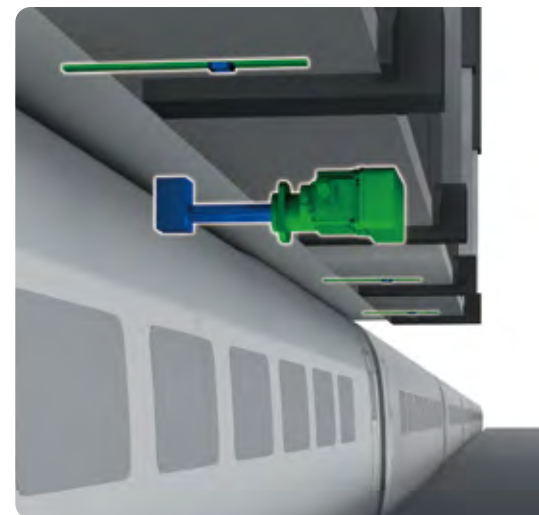

Electric actuator with clutch

クラッチ付き
電動アクチュエータ

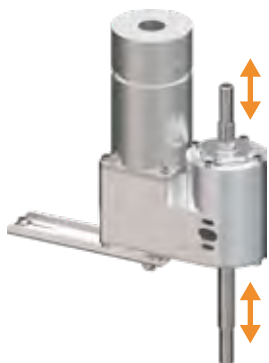

Electric actuator with clutch

クラッチ付き
電動アクチュエータ



High-thrust press actuator

高推力プレス用
アクチュエータ



Global Service Network — Europe



● **THK Manufacturing of Europe S. A. S. (France)**
 Site: 198,559m² (2,137,289sq.ft.) / Floor space: 39,379m² (423,876sq.ft.)



● **THK Manufacturing of Ireland Ltd. (Ireland)**
 Site: 10,198m² (109,771sq.ft.) / Floor space: 4,291m² (46,188sq.ft.)



● **THK RHYTHM AUTOMOTIVE GmbH (Krefeld Gellep)**
 Site: 64,021m² (689,119sq.ft.) / Floor space: 18,000m² (193,750sq.ft.)



● **THK RHYTHM AUTOMOTIVE CZECH a.s. (Czech Republic)**
 Site: 130,000m² (1,399,308sq.ft.) / Floor space: 53,900m² (580,175sq.ft.)



● **THK RHYTHM AUTOMOTIVE GmbH R&D Center (Düsseldorf)**
 Site: 6,524m² (70,224sq.ft.) / Floor space: 4,830m² (51,990sq.ft.)

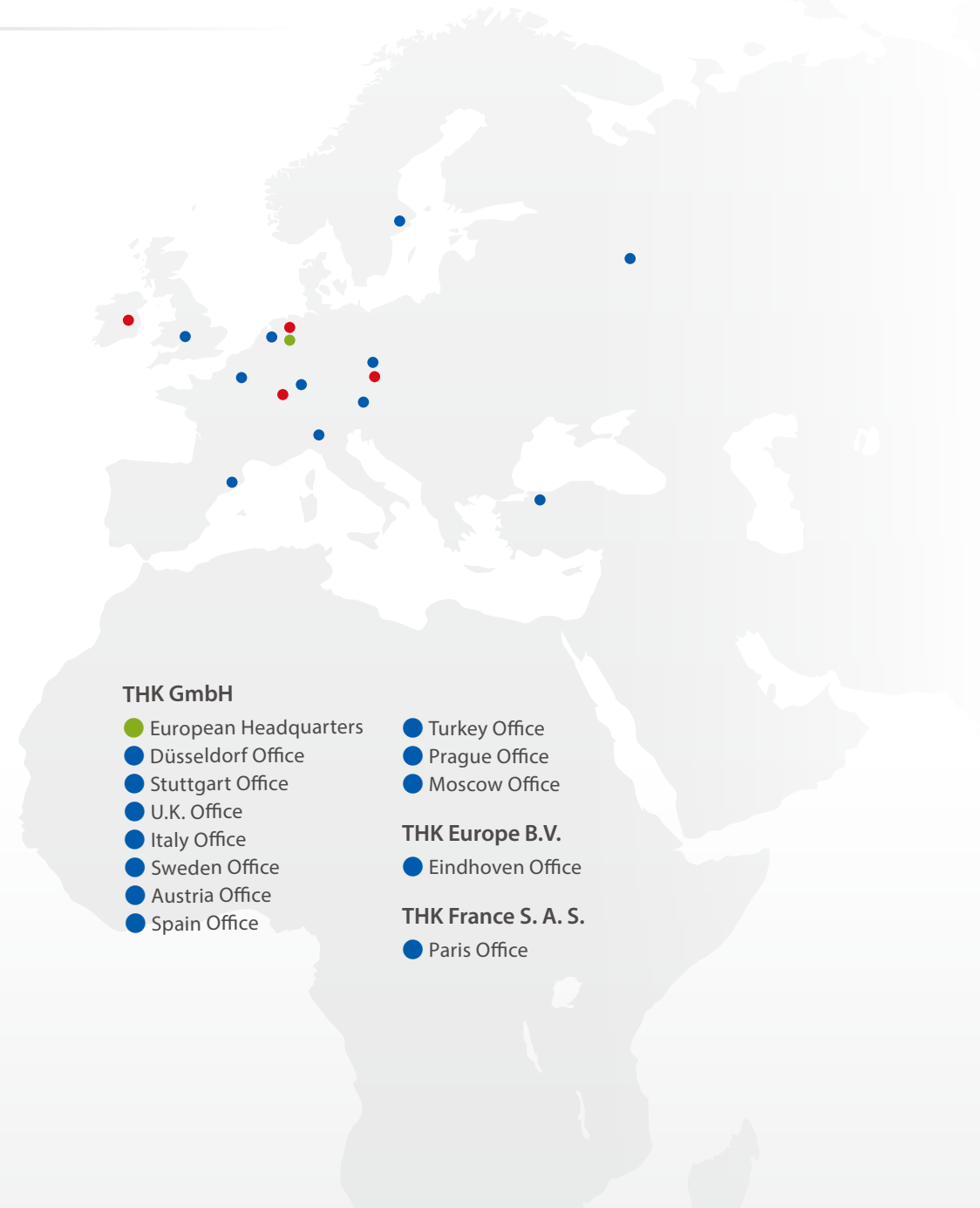

Americas

North America

THK America, Inc.

- Headquarters
- Chicago Office
- North East Office
- Atlanta Office
- Los Angeles Office
- San Francisco Office
- Detroit Office
- Toronto Office

South America

THK BRAZIL INDUSTRIA E COMERCIO LTDA.

- Sao Paulo Office



● THK Manufacturing of America, Inc. (USA)
Site: 109,058m² (1,173,900sq.ft.) / Floor space: 37,311m² (401,692sq.ft.)



● THK RHYTHM NORTH AMERICA CO., LTD. (USA)
Site: 116,496m² (1,253,662sq.ft.) / Floor space: 17,960m² (193,320sq.ft.)



● THK RHYTHM MEXICANA, S.A. DE C.V. (Mexico)
Site: 91,847m² (988,632sq.ft.) / Floor space: 16,430m² (176,851sq.ft.)



● THK RHYTHM AUTOMOTIVE MICHIGAN CORPORATION (USA)
Site: 307,559m² (3,310,538sq.ft.) / Floor space: 17,569m² (189,108sq.ft.)



● THK RHYTHM AUTOMOTIVE CANADA LIMITED (ST.Catharines)
Site: 117,763m² (1,267,596sq.ft.) / Floor space: 41,347m² (445,000sq.ft.)



● THK RHYTHM AUTOMOTIVE CANADA LIMITED (Tillsonburg)
Site: 60,540m² (651,657sq.ft.) / Floor space: 10,870m² (117,000sq.ft.)

Japan



● **Kofu Plant**
Site: 38,292m² (412,172sq.ft.) / Floor space: 25,957m² (279,399sq.ft.)



● **Yamaguchi Plant**
Site: 187,182m² (2,014,810sq.ft.) / Floor space: 68,515m² (737,490sq.ft.)



● **Yamagata Plant**
Site: 175,294m² (1,886,850sq.ft.) / Floor space: 103,665m² (1,115,841sq.ft.)



● **Mie Plant**
Site: 42,259m² (454,872sq.ft.) / Floor space: 25,405m² (273,457sq.ft.)



● **Gifu Plant**
Site: 86,856m² (934,910sq.ft.) / Floor space: 26,966m² (290,260sq.ft.)



● **THK NIIGATA CO., LTD.**
Site: 47,132m² (505,904sq.ft.) / Floor space: 15,162m² (163,202sq.ft.)



● **THK RHYTHM CO., LTD., Headquarters and Hamamatsu Plant**
Site: 97,629m² (1,050,870sq.ft.) / Floor space: 43,485m² (468,069sq.ft.)



● **THK RHYTHM CO., LTD., Inasa Plant**
Site: 7,237m² (77,898sq.ft.) / Floor space: 2,625m² (28,256sq.ft.)



● **THK RHYTHM CO., LTD., Kyushu Plant**
Site: 46,068m² (495,872sq.ft.) / Floor space: 21,057m² (226,655sq.ft.)



THK CO., LTD.

- Tokyo (Unit I)
- Hachioji
- Nagoya
- Osaka
- Tokyo (Unit II)
- Atsugi
- Toyota
- Kyoto
- Fukuoka
- Kawagoe
- Shizuoka
- Komaki
- Shiga
- Hiroshima
- Sendai
- Numazu
- Kanazawa
- Kobe
- Matsuyama
- Akita
- Hamamatsu
- Utsunomiya
- Kofu
- Suwa
- Ueda
- Nagaoka
- Hitachi
- Kumamoto

● Headquarters of Local Subsidiary ● Production Facility ● Sales Office ● Representative Office

Asia

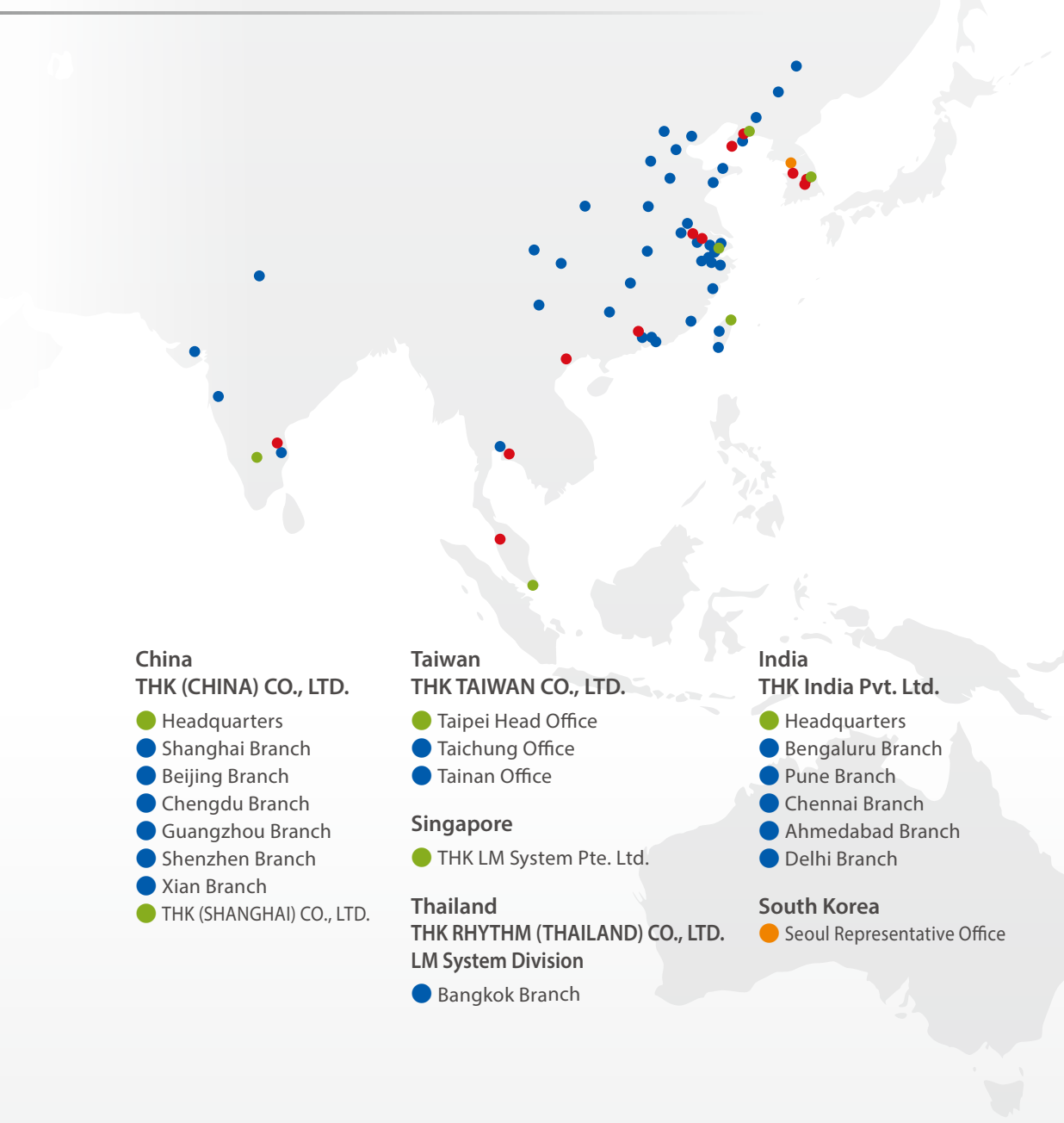

China
THK (CHINA) CO., LTD.

- Headquarters
- Shanghai Branch
- Beijing Branch
- Chengdu Branch
- Guangzhou Branch
- Shenzhen Branch
- Xian Branch
- THK (SHANGHAI) CO., LTD.

Taiwan
THK TAIWAN CO., LTD.

- Taipei Head Office
- Taichung Office
- Tainan Office

Singapore

- THK LM System Pte. Ltd.

Thailand
THK RHYTHM (THAILAND) CO., LTD.

- LM System Division
- Bangkok Branch

India
THK India Pvt. Ltd.

- Headquarters
- Bengaluru Branch
- Pune Branch
- Chennai Branch
- Ahmedabad Branch
- Delhi Branch

South Korea

- Seoul Representative Office



● THK MANUFACTURING OF CHINA (LIAONING) CO., LTD.
Site: 163,108m² (1,755,740sq.ft.) / Floor space: 58,755m² (632,434sq.ft.)



● THK MANUFACTURING OF CHINA (WUXI) CO., LTD.
Site: 155,256m² (1,671,219sq.ft.) / Floor space: 53,723m² (578,270sq.ft.)



● DALIAN THK CO., LTD. (China)
Site: 90,232m² (971,249sq.ft.) / Floor space: 52,715m² (567,420sq.ft.)



● THK MANUFACTURING OF CHINA (CHANGZHOU) CO., LTD.
Site: 54,556m² (587,236sq.ft.) / Floor space: 14,008m² (150,781sq.ft.)



● THK MANUFACTURING OF VIETNAM CO., LTD.
Site: 19,553m² (210,466sq.ft.) / Floor space: 23,525m² (253,221sq.ft.)



● THK RHYTHM (THAILAND) CO., LTD.
Site: 18,400m² (198,058sq.ft.) / Floor space: 3,000m² (32,292sq.ft.)



● THK RHYTHM MALAYSIA Sdn. Bhd.
Site: 6,070m² (65,337sq.ft.) / Floor space: 4,344m² (46,760sq.ft.)



● THK RHYTHM (CHANGZHOU) CO., LTD.
Site: 50,008m² (538,282sq.ft.) / Floor space: 12,488m² (134,424sq.ft.)



● THK RHYTHM GUANGZHOU CO., LTD. (China)
Site: 22,196m² (238,924sq.ft.) / Floor space: 8,654m² (93,154sq.ft.)

THK CO., LTD.

Headquarters 2-12-10 Shibaura, Minato-ku, Tokyo 108-8506 Japan

International Sales Department Phone: +81-3-5730-3860

www.thk.com

Europe

THK GmbH

- European Headquarters.....Phone: +49-2102-7425-555
 - Düsseldorf OfficePhone: +49-2102-7425-0
 - Stuttgart Office.....Phone: +49-7141-4988-500
 - U.K. Office.....Phone: +44-1384-471550
 - Italy Office.....Phone: +39-02-9901-1801
 - Sweden Office.....Phone: +46-8-445-7630
 - Austria Office.....Phone: +43-7229-51400
 - Spain Office.....Phone: +34-93-652-5740
 - Turkey Office.....Phone: +90-216-362-4050
 - Prague OfficePhone: +420-2-41025-100
 - Moscow Office.....Phone: +7-495-649-80-47
- THK Europe B.V.
- Eindhoven Office.....Phone: +31-40-290-9500
- THK France S.A.S.
- Paris Office.....Phone: +33-1-7425-3800

North America

THK America, Inc.

- Headquarters.....Phone: +1-847-310-1111
- Chicago OfficePhone: +1-847-310-1111

- North East Office.....Phone: +1-631-244-1565
- Atlanta Office.....Phone: +1-770-840-7990
- Los Angeles OfficePhone: +1-949-955-3145
- San Francisco Office.....Phone: +1-925-455-8948
- Detroit OfficePhone: +1-248-858-9330
- Toronto OfficePhone: +1-905-820-7800

South America

THK BRAZIL INDUSTRIA E COMERCIO LTDA.

-Phone: +55-11-3767-0100

China

THK (CHINA) CO., LTD.

- HeadquartersPhone: +86-411-8733-7111
 - Shanghai Branch.....Phone: +86-21-6219-3000
 - Beijing Branch.....Phone: +86-10-8441-7277
 - Chengdu BranchPhone: +86-28-8526-8025
 - Guangzhou BranchPhone: +86-20-8523-8418
 - Shenzhen Branch.....Phone: +86-755-2642-9587
 - Xian Branch.....Phone: +86-29-8834-1712
- THK (SHANGHAI) CO., LTD.Phone: +86-21-6275-5280

Taiwan

THK TAIWAN CO., LTD.

- Taipei Headquarters.....Phone: +886-2-2888-3818
- Taichung OfficePhone: +886-4-2359-1505
- Tainan OfficePhone: +886-6-289-7668

South Korea

- Seoul Representative Office.....Phone: +82-2-3468-4351

Singapore

THK LM System Pte. Ltd.....Phone: +65-6884-5500

Thailand

THK RHYTHM (THAILAND) CO., LTD. LM System Division

- Bangkok Branch.....Phone: +66-2751-3001

India

THK India Pvt. Ltd.

- Headquarters & Bengaluru BranchPhone: +91-80-2340-9934
- Pune Branch.....Phone: +91-72-7600-2071
- Chennai Branch.....Phone: +91-44-4042-3132
- Ahmedabad BranchPhone: +91-79-6134-4925
- Delhi Branch.....Phone: +91-12-4676-8695